

WARNING

If the filling is not done immediately:
ballast the tank with a minimum of 5 cm of liquid

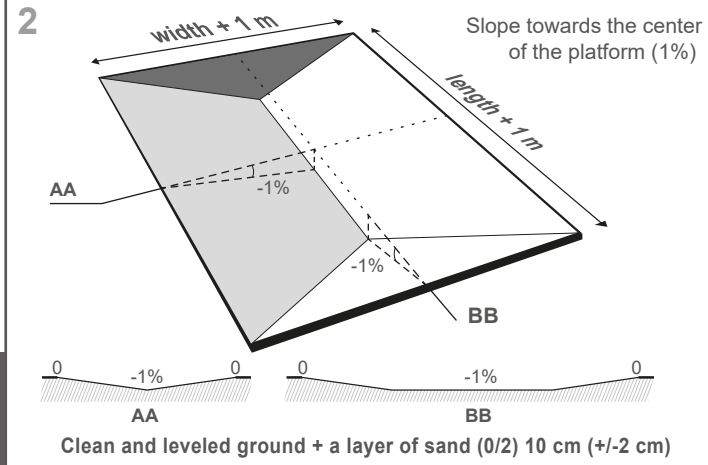

3

IMPORTANT
Installation of the tank according to its volume

V. (m ³)	Number of people
1 to 180	1 to 2
180 to 480	3 to 4
480 to 700	4 to 6

It is **strictly forbidden** to handle the product with machines to avoid any deterioration

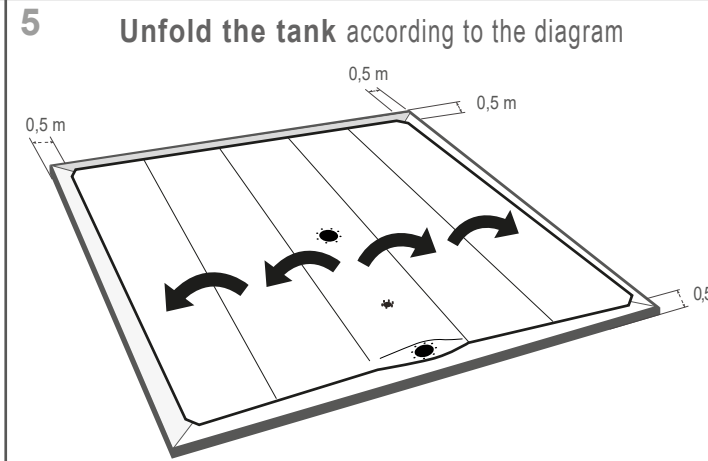
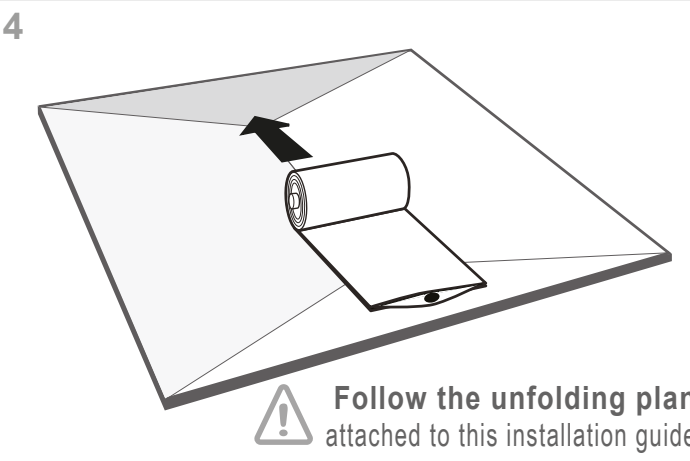

6

MANDATORY

Mounting pads necessarily before filling for each angle

x4

Use a 10mm wrench (not provided)

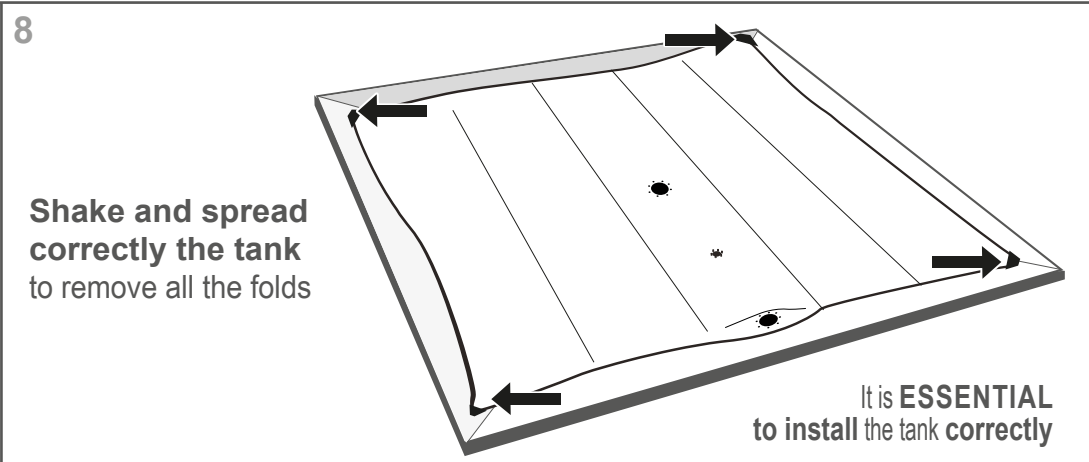
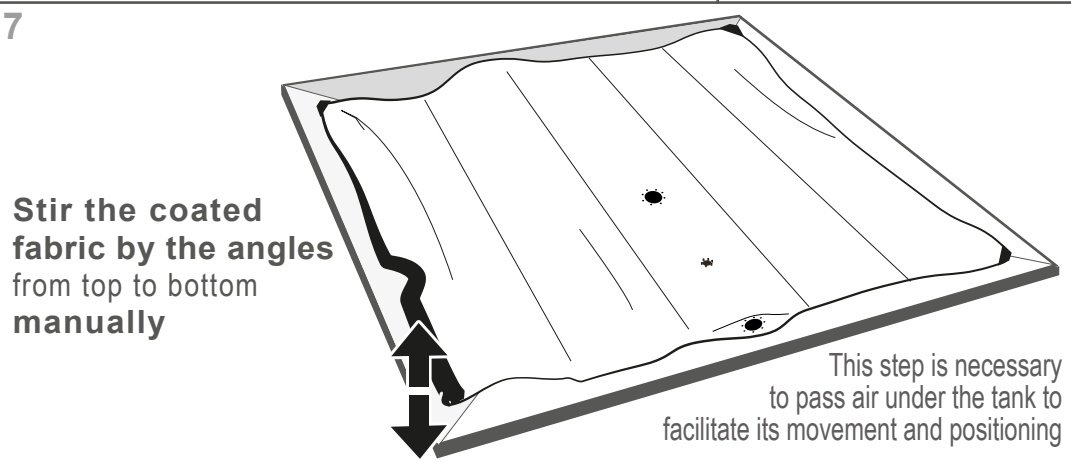



9 FOR ALL THE INLETS/OUTLETS

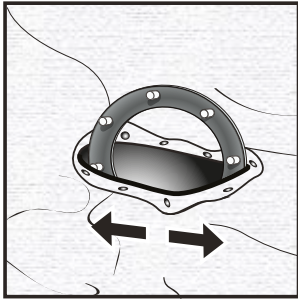

STRETCH WITH CARE
without tools, in order to pass
inside the counterflange with its seal

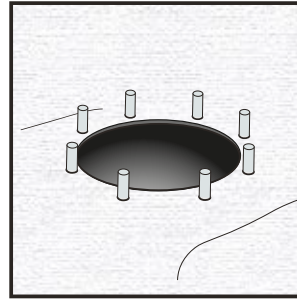

**Install correctly
the counterflange
in its socket**

10

Use a 13mm wrench
(not provided)

**! Overtightening can cause
the counterflange to break**

11

Use a 13mm wrench
(not provided)

**! Overtightening can cause
the counterflange to break**

12

**ESSENTIAL STEPS
TO RENEW**

**1 - Stir the tank by the angles
from top to bottom still
manually**

**2 - Shake and
spread correctly the tank:
remove all the folds on the surface before filling**

13

**Follow the instructions
for use**